

Instruction Manual

PLEASE READ THESE INSTRUCTIONS CAREFULLY BEFORE INSTALLATION

Item: SPL0301/0302/0501/0502/0503/0801/0901/0902/0903 Series

Spec: Aluminium 3W/5W/8W/9W LED SPOT LIGHT, IP67, 12/24V

Note: • A 12/24V transformer or constant voltage driver is required (not included).

- For 5W and 9W Series, input wattage must be 50% higher than the rated LED wattage to insure LED start-up.
- Fittings must be connected in parallel.
- Always switch off the mains supply before installation.

1. For Solid Ground Mounting

1.1 Separate the bracket from housing by unscrew the M3 screws by allen key. (See Fig 1.1)

1.2 Fix the bracket on the position by anchors and wooden screws. (See Fig 1.2)

1.3 Assemble the bracket to housing by the M3 screws. (See Fig 1.3)

1.4 Connect the 12/24V supply cable via waterproof junction box or connector.

Connect the light fitting cable to the junction box. (See Fig 1.4)

CAUTION: MUST USE IP67 OR IP68 JUNCTION BOX.

1.5 Switch on the mains supply, check and make sure the light fitting is on.

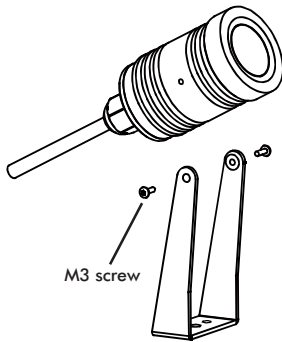

Fig 1.1

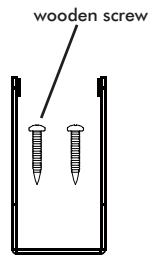

Fig 1.2

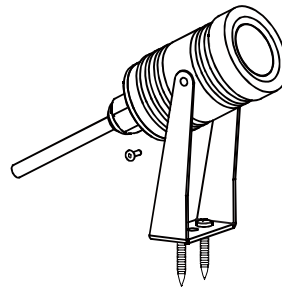

Fig 1.3

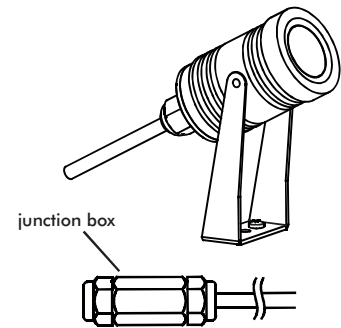

Fig 1.4

2. For Soft Ground Mounting (An Additional Spike is Necessary)

2.1 Separate the bracket from housing by unscrew the M3 screws by allen key. (See Fig 2.1)

2.2 Remove the M5 screw from spike (See Fig 2.2)

2.3 Insert the spike the into ground, fix the bracket on the top of spike by the M5 screw. (See Fig 2.3)

2.4 Assemble the bracket to housing by the M3 screws. (See Fig 2.4)

2.5 Connect the 12/24V supply cable via waterproof junction box or connector.

Connect the light fitting cable to the junction box. (See Fig 2.5)

CAUTION: MUST USE IP67 OR IP68 JUNCTION BOX.

2.6 Switch on the mains supply, check and make sure the light fitting is on.

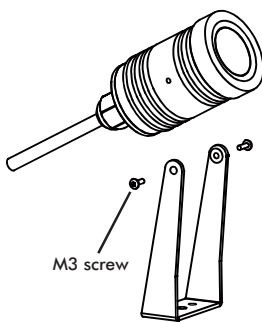

Fig 2.1

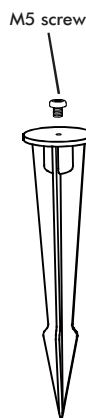

Fig 2.2

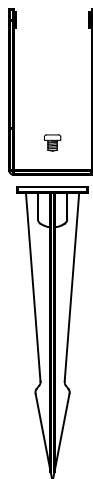

Fig 2.3

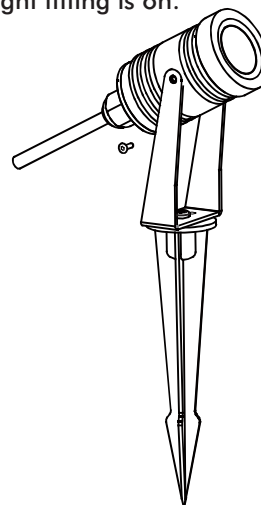

Fig 2.4

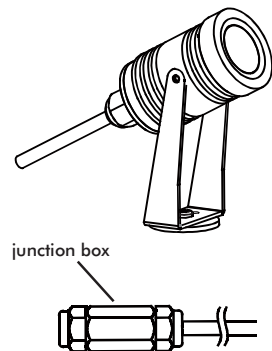

Fig 2.5

CAUTION:

ALL THE INSTALLATION MUST BE COMPLETED BY A QUALIFIED ELECTRICIAN!

Instruction Manual

PLEASE READ THESE INSTRUCTIONS CAREFULLY BEFORE INSTALLATION

Item: SPL0301/0302/0501/0502/0503/0801/0901/0902/0903 Series

Spec: Aluminium 3W/5W/8W/9W LED SPOT LIGHT, IP67, 12/24V

Note: • A 12/24V transformer or constant voltage driver is required (not included).

- For 5W and 9W Series, input wattage must be 50% higher than the rated LED wattage to insure LED start-up.
- Fittings must be connected in parallel.
- Always switch off the mains supply before installation.

1. For Solid Ground Mounting

1.1 Separate the bracket from housing by unscrew the M3 screws by allen key. (See Fig 1.1)

1.2 Fix the bracket on the position by anchors and wooden screws. (See Fig 1.2)

1.3 Assemble the bracket to housing by the M3 screws. (See Fig 1.3)

1.4 Connect the 12/24V supply cable via waterproof junction box or connector.

Connect the light fitting cable to the junction box. (See Fig 1.4)

CAUTION: MUST USE IP67 OR IP68 JUNCTION BOX.

1.5 Switch on the mains supply, check and make sure the light fitting is on.

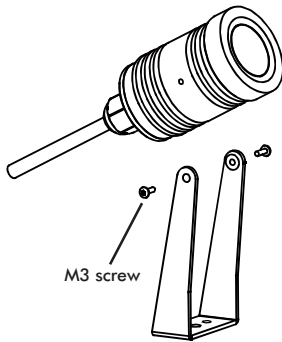

Fig 1.1

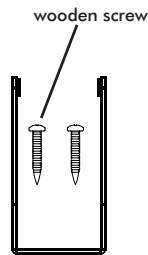

Fig 1.2

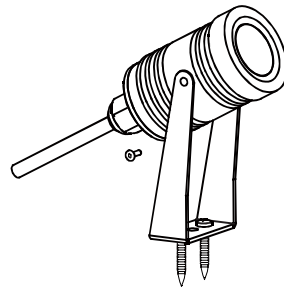

Fig 1.3

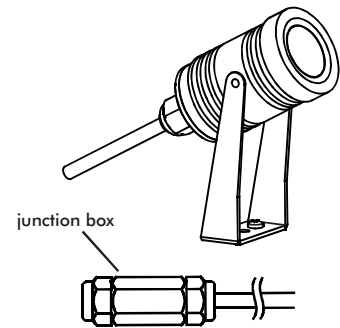

Fig 1.4

2. For Soft Ground Mounting (An Additional Spike is Necessary)

2.1 Separate the bracket from housing by unscrew the M3 screws by allen key. (See Fig 2.1)

2.2 Remove the M5 screw from spike (See Fig 2.2)

2.3 Insert the spike the into ground, fix the bracket on the top of spike by the M5 screw. (See Fig 2.3)

2.4 Assemble the bracket to housing by the M3 screws. (See Fig 2.4)

2.5 Connect the 12/24V supply cable via waterproof junction box or connector.

Connect the light fitting cable to the junction box. (See Fig 2.5)

CAUTION: MUST USE IP67 OR IP68 JUNCTION BOX.

2.6 Switch on the mains supply, check and make sure the light fitting is on.

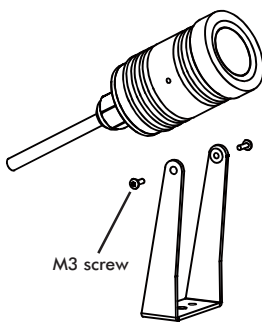

Fig 2.1

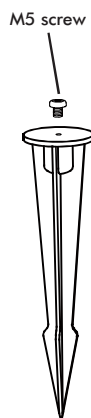

Fig 2.2

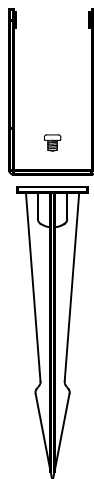

Fig 2.3

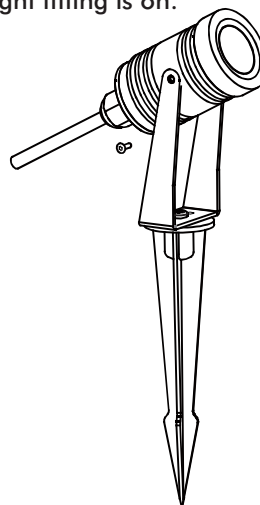

Fig 2.4

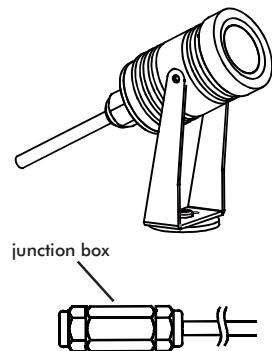

Fig 2.5

CAUTION:

ALL THE INSTALLATION MUST BE COMPLETED BY A QUALIFIED ELECTRICIAN!